

Dialogannahme

TRUCK TYRE CHANGER - ACCESSORIES

Version 2026.04.25 – Prices on request

Rim clamp

Article number: 1695300099

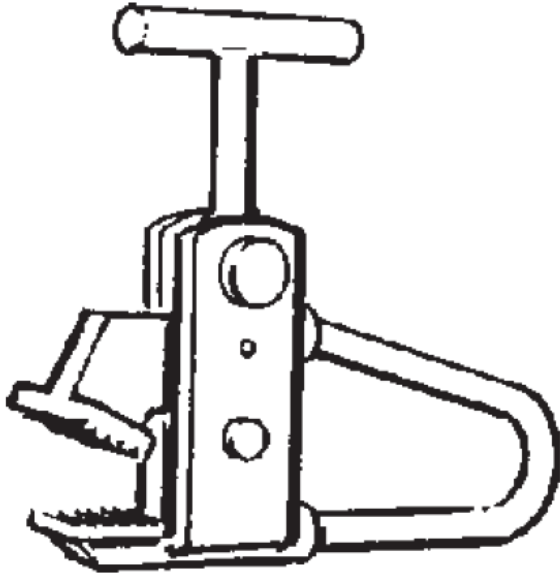

Split ring wheel clamp | for OTR (Off-the-road) wheels

Article number: 1695300098



56" clamping jaw extensions | 4 pcs. | TC1150HD

Article number: 1692402005



OTR Adapter | 4 pcs. | TC1150HD

Article number: 1692402006

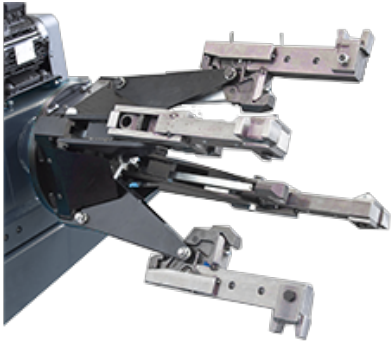

Set internal hole adapter 100mm | TC1150HD

Article number: 1692402007

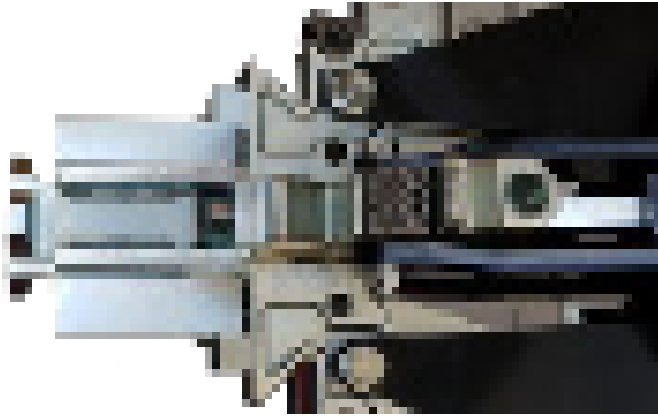

Protection kit clamping jaws | 4 pcs. | TC1150HD

Article number: 1692402008



Protection kit clamping jaws | 4 pcs. | TC850HD

Article number: 1692402009



Clamp for aluminium rims | Truck

Article number: 1692402010



Rim protection ring | 281mm | for 22,5" aluminium rims

Article number: 1692402011



Electronic inflation computer | for tyre inflation cage

Electronic control and display of inflation process. For inflation cage 1692402000.

Article number: 1692402013



Easy Automatic Inflation

On request, the inflation cage can be equipped with an electronic system which allows a standalone inflating process. The main feature is that once the necessary pressure has been set and the process started, the pressure gauge completes the operation unassisted, leaving the operator free to carry out other tasks. Max pressure: 10bar

For inflation cage 1692402000

Pneumatic Bead Depressor | for truck tyre changers MS 70/75/78/80

Article number: 1695103526



Center hole adapter from 80mm | for MS 78 and MS 80 | 6 pcs.

Article number: 1695301747

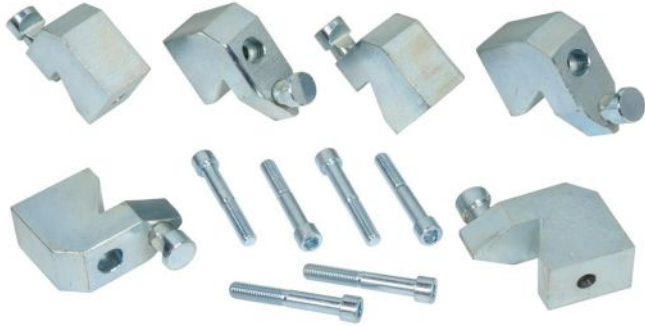

Extension claws for thick rim flanges | for MS 78 and MS 80 | 6 pcs.

Article number: 1695301748

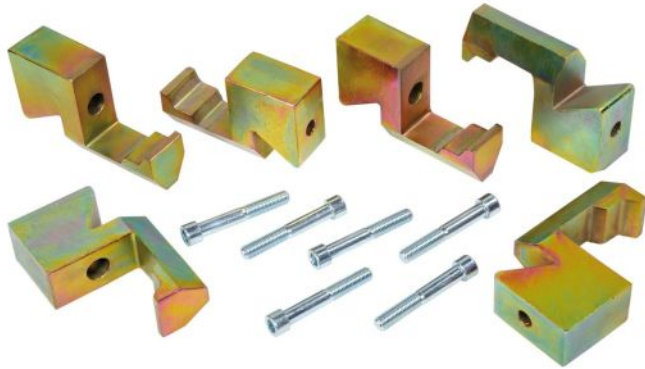

Protection jaws for aluminium rims | 26" | 4 pcs.

For fitting to the clamping jaws

Article number: 1695400139



Protection jaws for aluminium rims | 52" | for MS 75 | 4 pcs.

Article number: 1695301711



Roller for tubeless tyres | for all truck tyre changers

Helps in demounting tubeless tyres

Article number: 1695300102



Clamping jaw extension up to 56" | for MS 75 | 4 pcs.

Article number: 1695301710



Protection jaws for aluminium rims | 56" | for MS 78 and MS 80 | 6 pcs.

Article number: 1695301575



Clamping jaw extension up to 60" | for MS 78 and MS 80 | 6 pcs.

Article number: 1695301606



Center hole adapter from 80 mm | for MS 75 | 4 pcs.

Article number: 1695301781



Caterpillar Adapter | for MS 78 and MS 80 | 6 pcs.

Article number: 1695301681

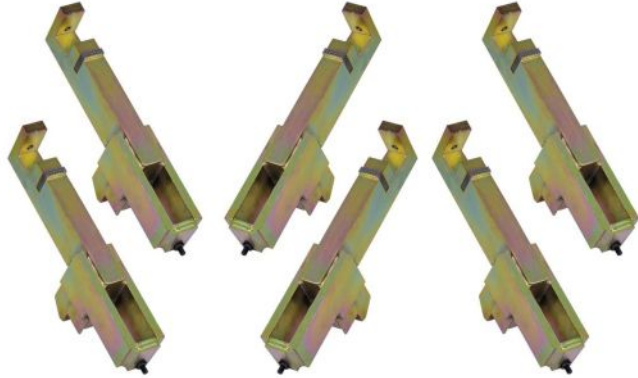

Extension claws for thick rim flanges | for MS 75 | 4 pcs.

Article number: 1695301782



Inflation Cage | for truck tyres

Safe inflation of truck tyres of up to 1450mm in diameter

Article number: 1692402000

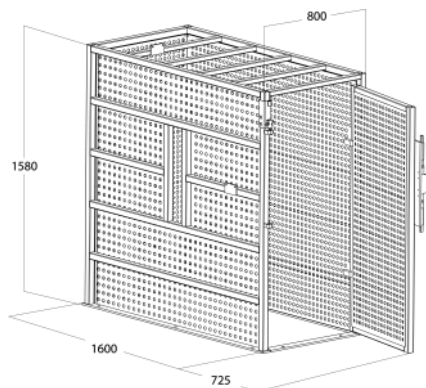

Safety First!

Protects user during inflation of industrial tyres with a diameter of up to 1450mm.

The special type of perforated mesh enclosing the structure minimizes the shock wave which might be generated by a tyre burst.

Scope of delivery:

- Inflation cage
- Inflation gun

Note: Electronic inflation control needs to be ordered separately.

Truck Tyre Changer - Accessories

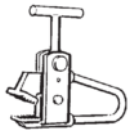

Rim clamp

Article number: 1695300099



Split ring wheel clamp | for OTR (Off-the-road) wheels

Article number: 1695300098



56" clamping jaw extensions | 4 pcs. | TC1150HD

Article number: 1692402005



OTR Adapter | 4 pcs. | TC1150HD

Article number: 1692402006



Set internal hole adapter 100mm | TC1150HD

Article number: 1692402007



Protection kit clamping jaws | 4 pcs. | TC1150HD

Article number: 1692402008



Protection kit clamping jaws | 4 pcs. | TC850HD

Article number: 1692402009



Clamp for aluminium rims | Truck

Article number: 1692402010



Rim protection ring | 281mm | for 22,5" aluminium rims

Article number: 1692402011



Electronic inflation computer | for tyre inflation cage

Article number: 1692402013



Pneumatic Bead Depressor | for truck tyre changers MS 70/75/78/80

Article number: 1695103526



Center hole adapter from 80mm | for MS 78 and MS 80 | 6 pcs.

Article number: 1695301747



Extension claws for thick rim flanges | for MS 78 and MS 80 | 6 pcs.

Article number: 1695301748



Protection jaws for aluminium rims | 26" | 4 pcs.

Article number: 1695400139



Protection jaws for aluminium rims | 52" | for MS 75 | 4 pcs.

Article number: 1695301711



Roller for tubeless tyres | for all truck tyre changers

Article number: 1695300102



Clamping jaw extension up to 56" | for MS 75 | 4 pcs.

Article number: 1695301710



Protection jaws for aluminium rims | 56" | for MS 78 and MS 80 | 6 pcs.

Article number: 1695301575



Clamping jaw extension up to 60" | for MS 78 and MS 80 | 6 pcs.

Article number: 1695301606



Center hole adapter from 80 mm | for MS 75 | 4 pcs.

Article number: 1695301781



Caterpillar Adapter | for MS 78 and MS 80 | 6 pcs.

Article number: 1695301681



Extension claws for thick rim flanges | for MS 75 | 4 pcs.

Article number: 1695301782



Inflation Cage | for truck tyres

Article number: 1692402000

IMPORTANT NOTES

- Please notice: This list contains spare parts, too.
- Without instruction or assembly.
- Delivery ex works including packaging.

VERSION 2026.04.25 – PRICES ON REQUEST

- Starting from now all previous lists will lose their validity.
- Please read our general terms and conditions in the latest version before ordering; to be found under www.beissbarth.com.

Order number 1 693 602 008 **Print norm** BB XXX / XX.XX.2020 DE · Subject to technical and program changes, errors excepted.

Beissbarth Automotive Testing Solutions GmbH

Friedrichshafener Str. 602
82205 Gilching, Germany
sales@beissbarth.com
www.beissbarth.com

Telefon: +49-(0)89-14901-0

Telefax: +49-(0)89-14901-246

