

Dialogannahme

EASY 3D+ - ACCESSORIES

Version 2026.05.12 – Prices on request

Cable set 12 m / 12 m

Cable set for four post lifts

Article number: 1690701029



Target boards 340 cm

Target boards for wheelbases > 340cm

Article number: 1690701032

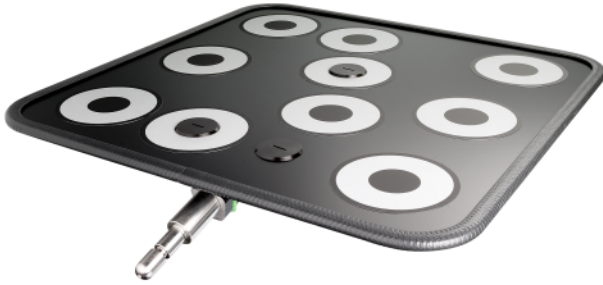

- Enables measurement of long wheelbases
- Only required for rear axle

Standard target board for Easy 3D

Article number: 1690711005



- No calibration required before use
- Lightweight and robust
- No exchange required after slight deformation of target
- No fixed position on the vehicle

Software Upgrade Easy3D to Easy 3D+ | Key Card

Article number: 1690701252



Upgrade or switch to the Beissbarth Plus-Software from an older 3D wheel aligner!

Calibration device for Easy 3D

Complete toolkit for a zero calibration of the reference camera system of a 3D sensor head in the field

Article number: 1690700014

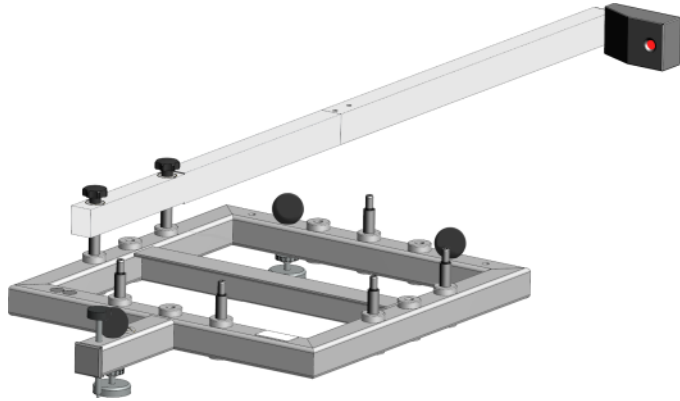

- Additionally, this tool can be used for an accuracy check in the workshop.

Cable set 25 m / 25 m

Cable set for vertical scissor lifts and special installations

Article number: 1690701163



Lift adapter one position

Article number: 1690701232

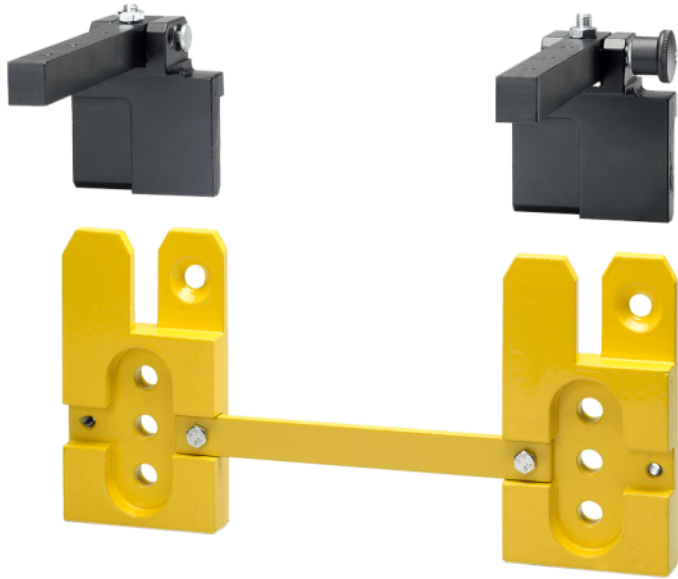

- For attachment of Easy 3D sensor heads on above and in-ground lifts
- One position for sensor heads

Floor adapter for alignment pits

Article number: 1690701027



- For attachment of Easy 3D sensor heads on alignment pits
- Position of sensor head is fixed

Lift adapter extension from one to two positions

Article number: 1690701503

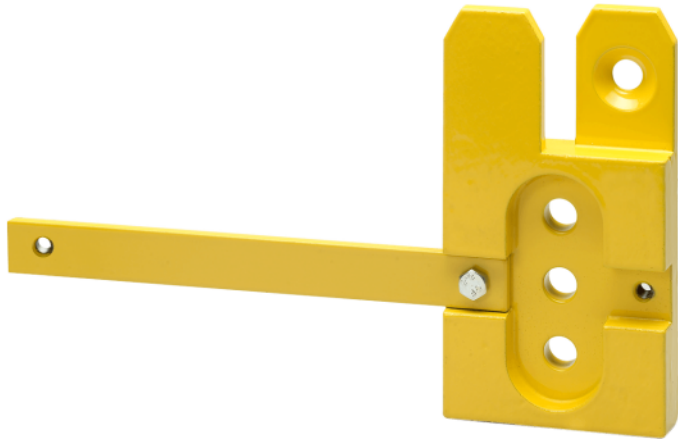

- Extends lift adapter with one position (1690701232) to two positions (1690701231)

Special lift adapter Extension for Beissbarth / Consul

For Beissbarth lifts VLH 4245, VLH 4345 and Consul 4-post lifts

Article number: 1690701311



- Extension of two-position adapter 1690701231 for attachment of Easy 3D sensor head on Beissbarth lifts VLH 4245, VLH 4345, and Consul 4-post lifts
- Two positions for sensor heads
- Use only as extension for two-position adapter 1690701231

Special lift adapter for lifts with U-profile

Article number: 1690701020

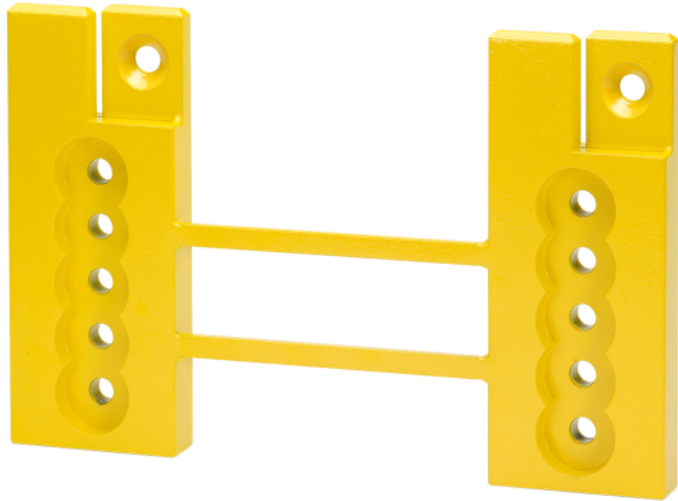

- For attachment of Easy 3D sensor heads on above and in-ground lifts
- One position for sensor heads

Cable set 15 m / 15 m

Cable set for scissor lifts

Article number: 1690701030



Wallhooks for Clamps and targets | for Easy3D+

Article number: 1690701040

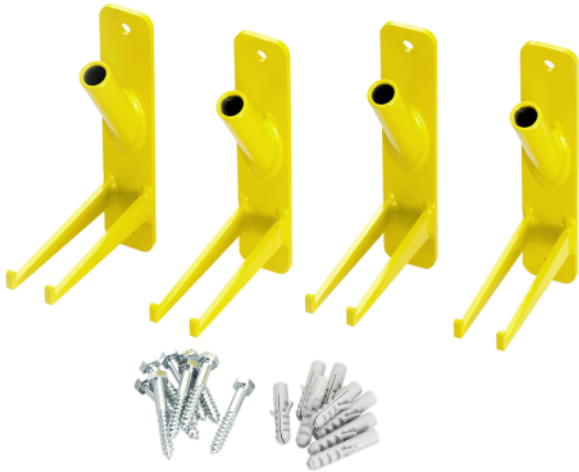

For space-saving storage of clamps and targets

Cable set 7.5 m / 7.5 m

Cable set for above ground pit solutions

Article number: 1690701205



Extension magnet for magnetic holder | 100 mm | 1 pc.

One 100mm magnet, three required for a magnetic clamp.

Article number: 1690701523



Magnetic clamps for wheel bolts | 75mm

Set of magnetic clamps for magnetic wheel bolts

Article number: 1690701508



- Quick and gentle attachment on wheel bolts instead of the rim
- Secure and central hold for ultimate precision
- Suited for 3/4/5/6 hole rims

Wallhooks for sensor heads | for Easy3D+

Article number: 1690701507

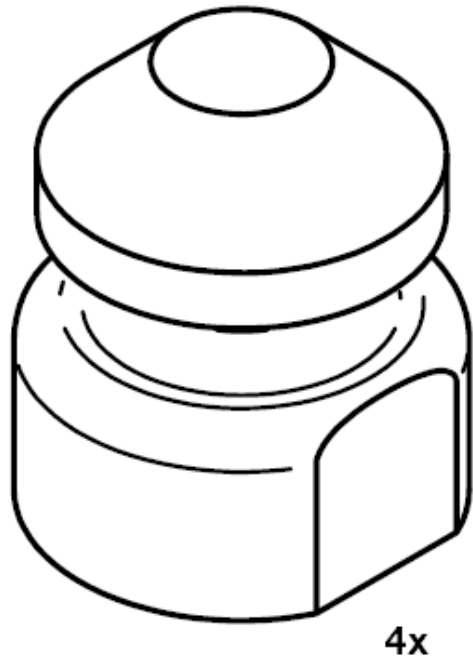

For space-saving storage of sensor heads when not in use

Magnetic clamps for wheel bolts | 100mm

Set of magnetic clamps for magnetic wheel bolts

Article number: 1690701521



- Quick and gentle attachment on wheel bolts instead of the rim
- Secure and central hold for ultimate precision
- Suited for 3/4/5/6 hole rims

Step protection for Easy 3D

Article number: 1690701045



Wheel chock set 2 pcs.

Prevents vehicle from rolling off the lift

Article number: 1692000156



Scope of delivery:

- 2 x Wheel chock

Special lift adapter for Beissbarth / Consul

For Beissbarth lifts VLH 4245, VLH 4345 and Consul 4-post lifts

Article number: 1690701123



- For attachment of Easy 3D sensor heads on Beissbarth lifts VLH 4245, VLH 4345 and Consul 4-post lifts
- Two positions for sensor heads

Lift adapter two positions

For attachment of Easy 3D sensor heads on above and in-ground lifts

Article number: 1690701231

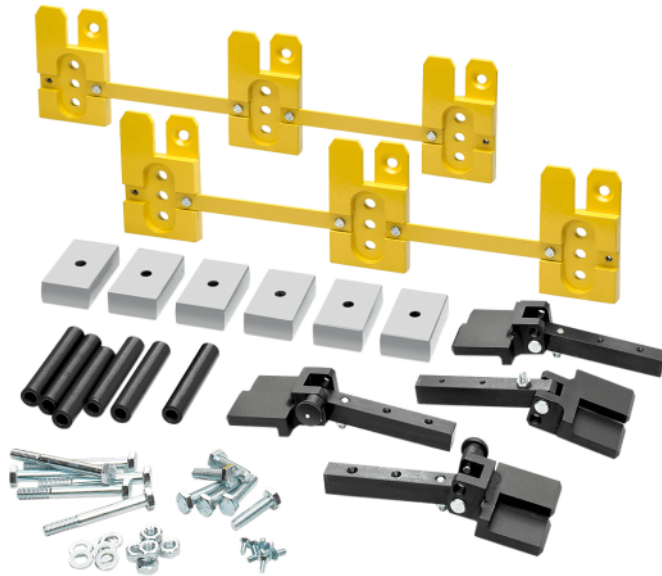

- Also adapted for FWA 4630

Floor adapter for LTB 100/300

Article number: 1690701506

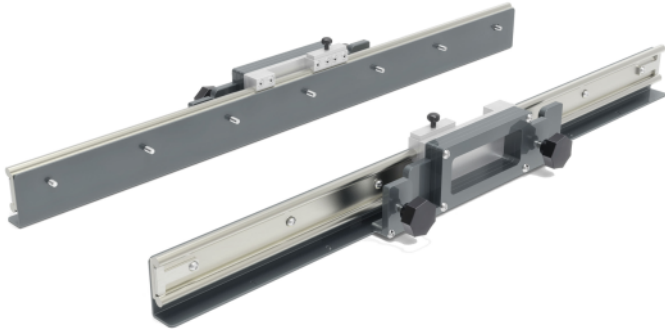

- Floor adapter - Levelled Test Bay LTB 100/300
- For attachment of Easy 3D sensor heads on levelled test bays LTB 100 and LTB 300
- Position of sensor head is adjustable in vehicle direction via rail system

Extension for vehicles with narrow track width or RVs

Article number: 1690701127

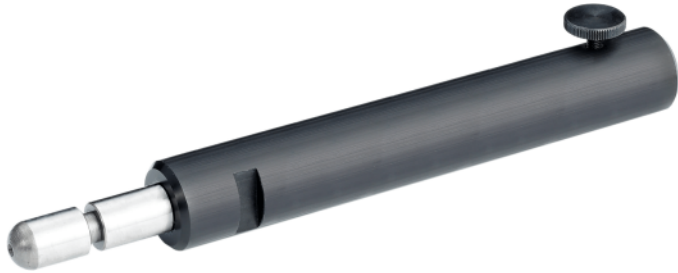

Extension of the measuring boards:

- When used with a very narrow vehicle: use 4x extension
- For motorhomes with a wide body: use 2x extension on rear axle

Brake lock

Article number: 1690102212



Windows 10 PC Upgrade | pre-installed | for CCD, 3D and Touchless

Article number: 1690101025



Steering wheel holder

Article number: 1690102213



Filling piece | for steel turntable 1690311002

1x Filling piece, required quantity: 2

Article number: 1690702157



Mechanical turntable | Steel | with Nonius

370 x 350 x 42mm, max. load: 800kg, turnplate diameter: 308mm Matching filling pieces: 1690702157

Article number: 1690311002



Ballast bag 20 kg

Used for vehicles that require loading to a specific ride height in order to perform alignment

Article number: 1693740003



Ballast bag 5 kg

Used for vehicles that require loading to a specific ride height in order to perform alignment

Article number: 1693740001



Filling piece (1x) for aluminum turntable

Article number: 1690102211



Filling piece for aluminum precision turntable

1x Precision filling piece for one precision turntable. Required quantity per turntable: 2

Article number: 1690102041



1x Precision filling piece for one precision turntable. Required quantity per turntable: 2

Steering Wheel Level Gauge | Bluetooth

Steering level gauge with electronic inclinometer for checking the steering level position during the wheel alignment.

Article number: 1693770683



Steering level gauge with electronic inclinometer for checking the steering level position during the wheel alignment. Save valuable time for every alignment as the steering level position is permanently monitored, especially when the vehicle is raised on the lift. Prevents crooked steering wheels and time-consuming comebacks.

Completely wireless and powered with integrated Li-Ion batteries. Alternatively, the USB used for charging the device can also be used for the data transmission.

- Measuring range: +/- 30° with accuracy of +/- 0,1°
- Max. Steering level position: 15°
- Operating time: 20 hrs
- Charging time: 4 hrs

Compatible with wheel aligners: BMW Q.Lign, BMW KDS 3D

Vehicle database update CCD/Easy3D | Key Card

Article number: 1690002023



- Access to the newest vehicles specs directly from the OEM
- Authorises the licensing of all IAM vehicle databases for the calendar year in which the Key Card has been activated

Set of Drive-on ramps | for RaceScales

4x drive-on ramps, e.g. RaceScales on lifts without turntable recess.

Article number: 1692000221

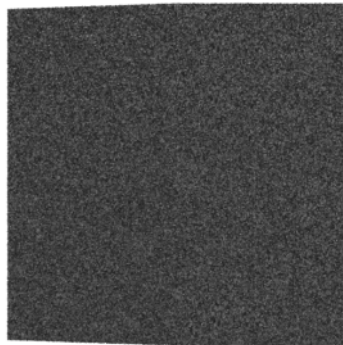

- Set of Drive-on ramps for turntables and sliding plates
- Suitable for lifts without cutouts for turntables or sliding plates, e.g. MOT lifts
- Made from recycled rubber granulate
- Withstands snow, water, salt, oil under normal workshop conditions
- Temperature stable between -30°C to 80°C
- Produced free from pollutants according to REACH

Dimensions:

- Height: 50mm
- Width: 495mm
- Length: 500mm
- Length rolling surface: 200mm
- Length slope: 300mm
- Slope: 8°

Vehicle database update Cars & Vans Europe | Online Download

Article number: 1690008100



[Data/licenses](#) [Key codes](#) [My profile](#) [Admin Center](#) [Document Center](#) [About us](#)

Data/licenses

We need the serial number of your device for the **licensing** and for determining the available software.

The serial number can be found on the rating plate.

The serial number consists of a two-digit product identification and a seven-digit device number.

Product identification*

Device number*

Mandatory fields are marked with *.

Send

Skip

- Online download on base-licensecenter.com

USB Remote control | for EasyCCD, Easy3D+ and Touchless

Remote control with USB receiver. For EasyCCD, Easy3D+ and Touchless. Requires software update of the aligner program. Powered by 2x AAA batteries.

Article number: 1693770586



Multi-Fit wheel clamp with standard claws | 13 - 22" | 4 pcs.

Article number: 1690311112



- High quality claws for gentle attachment to rims
- Torque control for strong hold without deforming the rim

Multi-Fit wheel clamp with standard claws | 13 - 22" | 1pc.

Article number: 1690311089



- High quality claws for gentle attachment to rims
- Torque control for strong hold without deforming the rim

Extension set for Multi-fit clamps | 23 - 28"

Article number: 1690311113



Set softline claws for 1 x Multi-fit clamp | Softline rims

Article number: 1690311164



Sliding plate for rear axle | short

Short sliding plate for rear axle, 450 mm

Article number: 1690401003

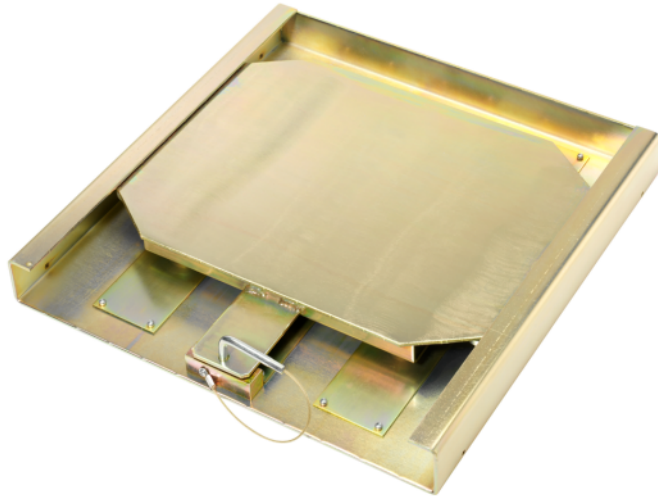

- +/- 10° rotating range

Sliding plate for rear axle | long

Long sliding plate for rear axle, 1050 mm

Article number: 1690401004

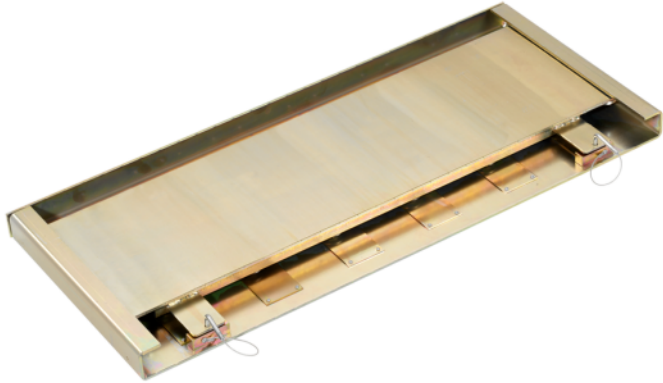

- +/-2.5° rotating range

Mechanical aluminum turntable Standard

Article number: 1690501001

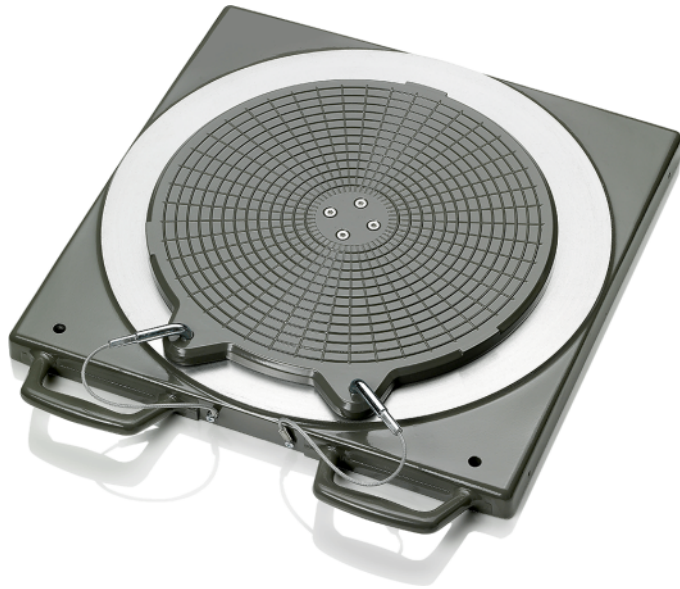

- Very high quality and lifetime in workshop environment

Protective rubber cover for aluminum turntable

Article number: 1690402001



- Additional protection from dirt and liquids

Drive-on ramps for two aluminum turntables

Article number: 1690701052

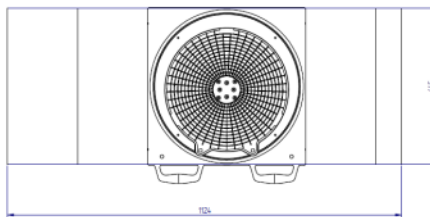

- Drive-on ramps for turntables including connecting piece and drive off protection
- Enables rolling compensation on lifts without embedded turntables

This product is suitable for two turntables.

Drive-on ramps for turntables and sliding plates

Article number: 1690401008

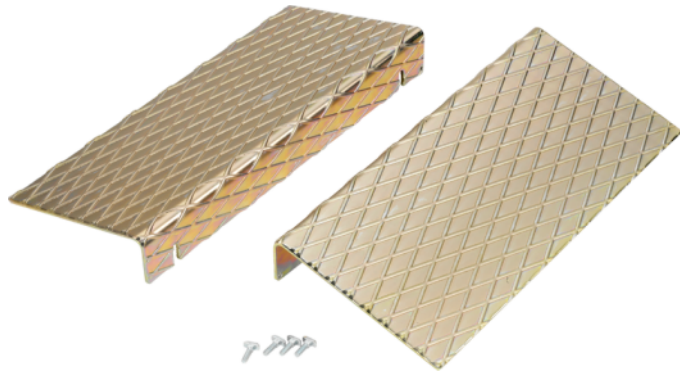

- Set of Drive-on ramps for turntables and sliding plates
- Suitable for lifts without cutouts for turntables or sliding plates, e.g. MOT lifts

Set truck claws for 1 x Multi-fit clamp | Truck

Article number: 1690311115



For convex wheels mounted to a double-bearing hub and dually wheels.

Length: 10cm

Romess inclinometer with standard adapter | 230V

For measuring the level of Mercedes-Benz vehicles on the front and rear axle

Article number: 1693770002



For measuring the level of Mercedes-Benz vehicles on the front and rear axle

- Measuring range: $\pm 15^\circ$ with accuracy of $\pm 0.1^\circ$
- Interface: RS-232, USB
- Data transfer: manual (automatic data transfer requires the Romess data transfer and charging unit 1693770003)

The included standard adapter plate is only required for types 170, 202, 208 and 210.

Romess data transfer and charging unit | 230V

Accessory for Romess inclinometer 1693770002.

Article number: 1693770003



Accessory for Romess inclinometer 1693770002.

Charges inclinometer when inserted into charging station.
Automatic data transfer between Romess inclinometer and wheel aligner.

Automatic data transfer only on wheel aligners EasyCCD,
Easy3D+ and Touchless.

Replacement standard adapter for Romess inclinometer

Article number: 1693770160



- For types: 170, 202, 208, 210
- Not required for types 168, 220 and all newer types

Original part: Romess 09606-50

Romess adapter set for Vaneo type W414

Article number: 1693770004



- Accessory for Romess Inclinator 1693770002

Original part: Romess 09606-62

Mechanical aluminum turntable Precision

Article number: 1690401028

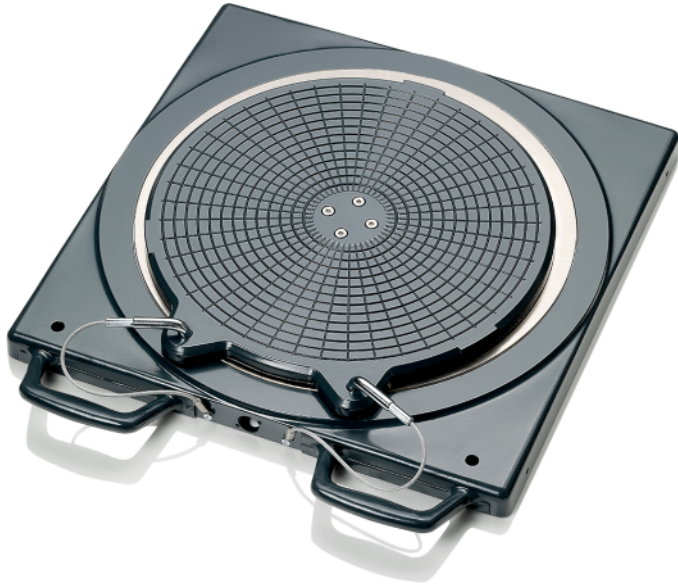

- Very high quality and lifetime in workshop environment
- Steel balls for minimal friction and maximum precision

Easy 3D+ - Accessories



Cable set 12 m / 12 m

Article number: 1690701029



Target boards 340 cm

Article number: 1690701032



Standard target board for Easy 3D

Article number: 1690711005



Software Upgrade Easy3D to Easy 3D+ | Key Card

Article number: 1690701252



Calibration device for Easy 3D

Article number: 1690700014



Cable set 25 m / 25 m

Article number: 1690701163



Lift adapter one position

Article number: 1690701232



Floor adapter for alignment pits

Article number: 1690701027



Lift adapter extension from one to two positions

Article number: 1690701503



Special lift adapter Extension for Beissbarth / Consul

Article number: 1690701311

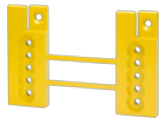

Special lift adapter for lifts with U-profile

Article number: 1690701020



Cable set 15 m / 15 m

Article number: 1690701030



Wallhooks for Clamps and targets | for Easy3D+

Article number: 1690701040



Cable set 7.5 m / 7.5 m

Article number: 1690701205



Extension magnet for magnetic holder | 100 mm | 1 pc.

Article number: 1690701523



Magnetic clamps for wheel bolts | 75mm

Article number: 1690701508



Wallhooks for sensor heads | for Easy3D+

Article number: 1690701507



Magnetic clamps for wheel bolts | 100mm

Article number: 1690701521

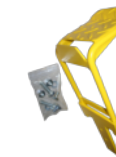

Step protection for Easy 3D

Article number: 1690701045



Wheel chock set 2 pcs.

Article number: 1692000156



Special lift adapter for Beissbarth / Consul

Article number: 1690701123



Lift adapter two positions

Article number: 1690701231



Floor adapter for LTB 100/300

Article number: 1690701506



Extension for vehicles with narrow track width or RVs

Article number: 1690701127



Brake lock

Article number: 1690102212



Windows 10 PC Upgrade | pre-installed | for CCD, 3D and Touchless

Article number: 1690101025



Steering wheel holder

Article number: 1690102213



Filling piece | for steel turntable 1690311002

Article number: 1690702157



Mechanical turntable | Steel | with Nonius

Article number: 1690311002



Ballast bag 20 kg

Article number: 1693740003



Ballast bag 5 kg

Article number: 1693740001



Filling piece (1x) for aluminum turntable

Article number: 1690102211



Filling piece for aluminum precision turntable

Article number: 1690102041



Steering Wheel Level Gauge | Bluetooth

Article number: 1693770683



Vehicle database update CCD/Easy3D | Key Card

Article number: 1690002023



Set of Drive-on ramps | for RaceScales

Article number: 1692000221



Vehicle database update Cars & Vans Europe | Online Download

Article number: 1690008100



USB Remote control | for EasyCCD, Easy3D+ and Touchless

Article number: 1693770586



Multi-Fit wheel clamp with standard claws | 13 - 22" | 4 pcs.

Article number: 1690311112



Multi-Fit wheel clamp with standard claws | 13 - 22" | 1pc.

Article number: 1690311089



Extension set for Multi-fit clamps | 23 - 28"

Article number: 1690311113



Set softline claws for 1 x Multi-fit clamp | Softline rims

Article number: 1690311164

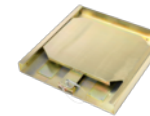

Sliding plate for rear axle | short

Article number: 1690401003



Sliding plate for rear axle | long

Article number: 1690401004

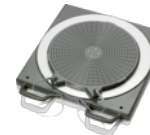

Mechanical aluminum turntable Standard

Article number: 1690501001



Protective rubber cover for aluminum turntable

Article number: 1690402001

**Drive-on ramps for two aluminum turntables**

Article number: 1690701052

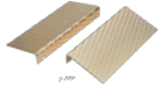
**Drive-on ramps for turntables and sliding plates**

Article number: 1690401008

**Set truck claws for 1 x Multi-fit clamp | Truck**

Article number: 1690311115

**Romess inclinometer with standard adapter | 230V**

Article number: 1693770002

**Romess data transfer and charging unit | 230V**

Article number: 1693770003

**Replacement standard adapter for Romess inclinometer**

Article number: 1693770160

**Romess adapter set for Vaneo type W414**

Article number: 1693770004

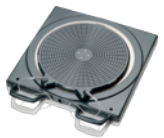
**Mechanical aluminum turntable Precision**

Article number: 1690401028

IMPORTANT NOTES

- Please notice: This list contains spare parts, too.
- Without instruction or assembly.
- Delivery ex works including packaging.

VERSION 2026.05.12 – PRICES ON REQUEST

- Starting from now all previous lists will lose their validity.
- Please read our general terms and conditions in the latest version before ordering; to be found under www.beissbarth.com.

Order number 1 693 602 008 **Print norm** BB XXX / XX.XX.2020 DE · Subject to technical and program changes, errors excepted.

Beissbarth Automotive Testing Solutions GmbH

Friedrichshafener Str. 602
82205 Gilching, Germany
sales@beissbarth.com
www.beissbarth.com

Telefon: +49-(0)89-14901-0
Telefax: +49-(0)89-14901-246

