

Dialogannahme

ADAS CALIBRATION

Version 2024.05.09 – Prices on request

BBFAS 415

Beissbarth BB FAS 415 - the flexible front camera calibration device for multi-brand system solutions

Article number: 8 900 380 008

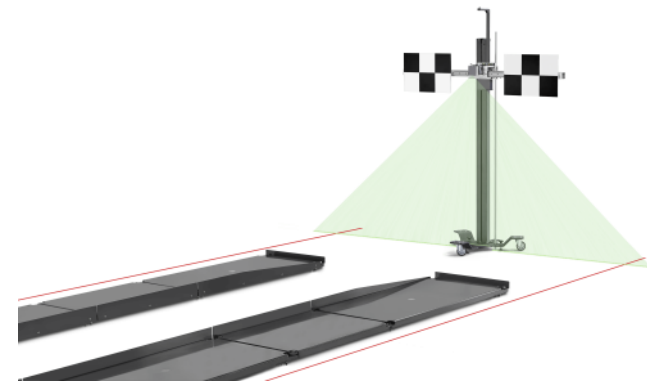
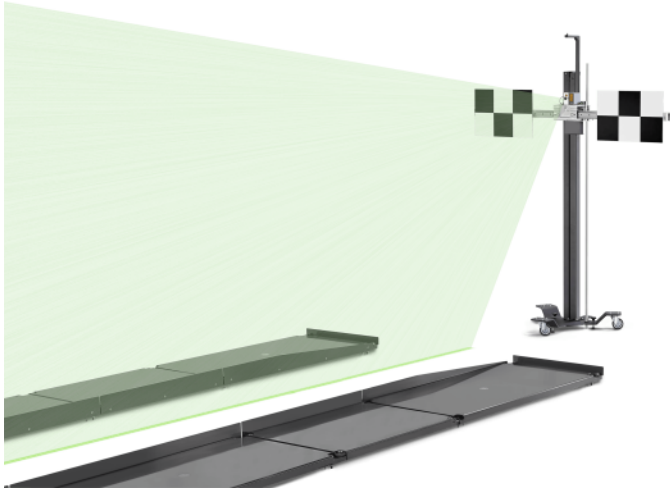

Front camera calibration with BBFAS 415 calibration device: Flexible, easy and precise

- static calibration of cameras e.g. Lane departure cameras, multifunction cameras
- Wide vehicle coverage through optional calibration Targets
- Fast, easy alignment to the vehicle's symmetrical axis or on to ground markings
- Alignment on to the vehicles track-width with optional accessories possible at any time
- Horizontal levelling according to precision spirit levels via three height-adjustable feet
- Precision crossbeam with slidingplate and fine adjusting screw
- Magnetic holding fixture for multi-brand calibration plates
- High power line laser module with low laser class (1M). Green laser diodes are particularly well visible to the human eye because the eye has its maximum spectral sensitivity in the green range.
- Optional: Compact storage box for modular calibration boards

Note: For adjusting the driver assistance systems, an OBD diagnostic device is also required

Scope of delivery:

- Precision crossbar with 2 magnetic sliding-plates for mounting of calibration Targets
- 4-wheel trolley with stable column for holding the crossbar
- Line laser module for aligning the calibration device
- Ruler for height adjustment

Note: Necessary calibration targets are not included

Distance measurement laser for BB FAS 415

Article number: 8 900 381 005

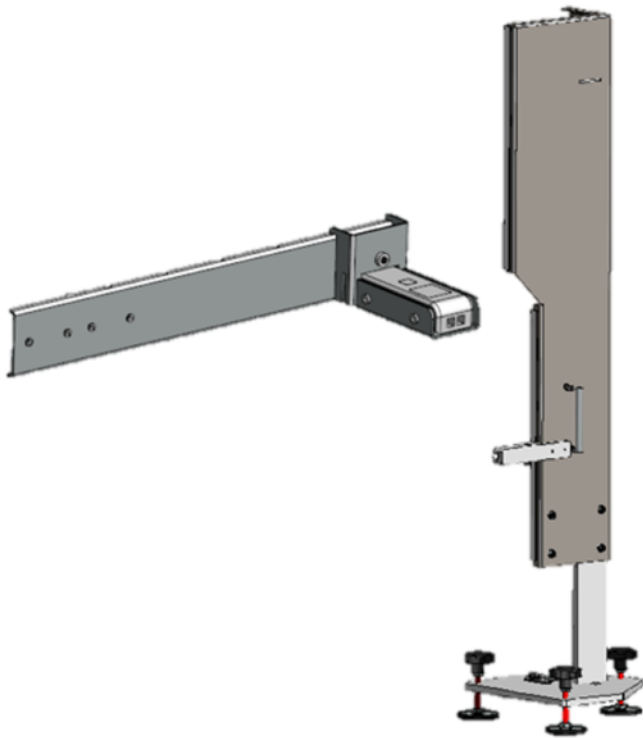

P-Assist

Article number: 8 900 381 138



- P-Assist wheel stands: Front and rear wheel stands for P-Assist laser alignment system for alignment to wheel-track.

Positioning target

Article number: 8 900 381 292



- Target panel for roof antennas for alignment with the vehicle's longitudinal axis

Without wheel aligner

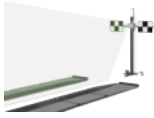

BBFAS 415

Article number: 8 900 380 008



Distance measurement laser for BB FAS 415

Article number: 8 900 381 005



P-Assist

Article number: 8 900 381 138



Positioning target

Article number: 8 900 381 292

IMPORTANT NOTES

- Please notice: This list contains spare parts, too.
- Without instruction or assembly.
- Delivery ex works including packaging.

VERSION 2024.05.09 – PRICES ON REQUEST

- Starting from now all previous lists will lose their validity.
- Please read our general terms and conditions in the latest version before ordering; to be found under www.beissbarth.com.

Order number 1 693 602 008 **Print norm** BB XXX / XX.XX.2020 DE · Subject to technical and program changes, errors excepted.

Beissbarth Automotive Testing Solutions GmbH

Hanauer Straße 101
80993 Munich, Germany
sales@beissbarth.com
www.beissbarth.com

Telefon: +49-(0)89-14901-0
Telefax: +49-(0)89-14901-246

